

45° Angled Panel Mounted Socket

Product Code :	BC1-1505-7420
Barcode :	8698523902967
IP Class :	IP67
Ampere :	5/16A
Volt :	380V-450V
Hertz :	50Hz - 60Hz
Pole :	3P+E+N
Body Material :	Polyamide 6
Conductor Material :	MS 58
Gram :	194,6
Box :	6
Package :	108

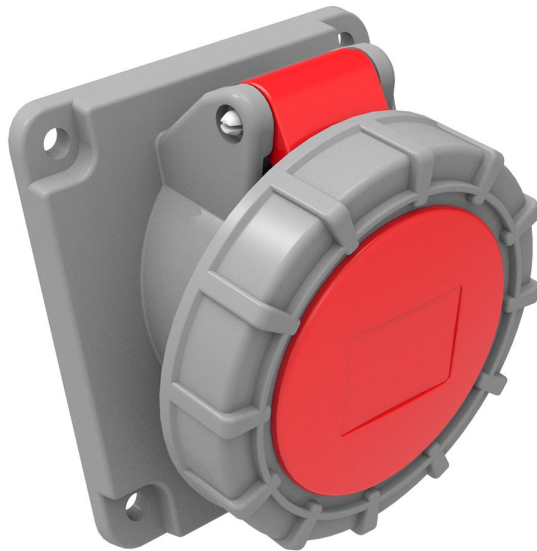

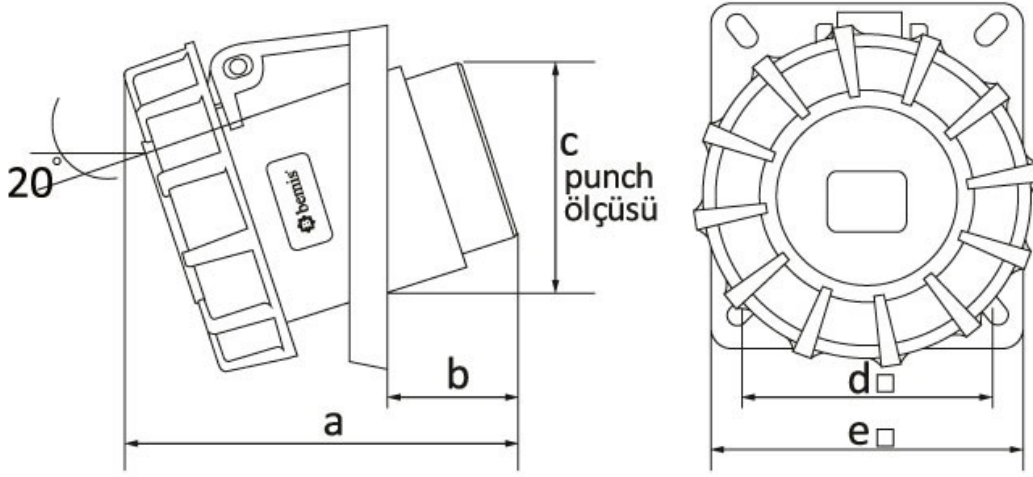

Ölçüler / Dimensions (mm)

a	88	e□	85
b	32	f	
c	70	g	
d□	70	h	

